

# Aging Effects of As-deposited and Passivated Slanted Columnar Thin Films



UNIVERSITY OF NEBRASKA-LINCOLN

D. Schmidt\*, E. Schubert, and M. Schubert

Department of Electrical Engineering and Center for Nanohybrid Functional Materials, University of Nebraska-Lincoln, U.S.A.

\*schmidt@huskers.unl.edu

http://ellipsometry.unl.edu

http://cnfm.unl.edu

## Our Message

- Glancing angle deposition is utilized to grow metallic sculptured thin films (STFs). Subsequently, a thin conformal  $\text{Al}_2\text{O}_3$  passivation layer is coated by means of atomic layer deposition (ALD).
- An anisotropic Bruggeman EMA approach is employed to analyze Mueller matrix ellipsometry spectra and to determine monoclinic optical and structural properties as well as fractions of film constituents.
- Core optical constants change upon deposition of a passivation layer, possibly due to the large surface area to volume ratio ( $\text{SA:V} = 190 \text{ m}^{-1}$ !).
- $\text{Al}_2\text{O}_3$  passivated STFs do not show aging effects!
- ALD is an excellent technique to functionalize STFs and modify their physical properties!

## Motivation

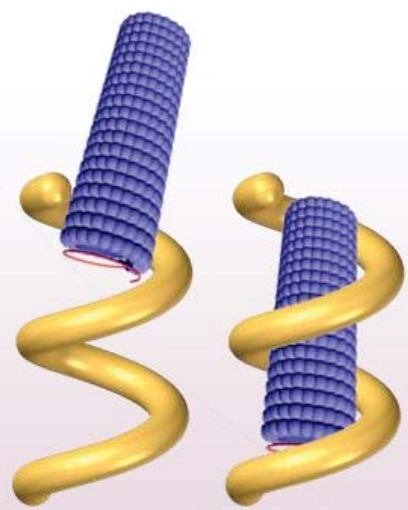

Selective capsid capturing in hollow-core nanohelices with matched dimensions

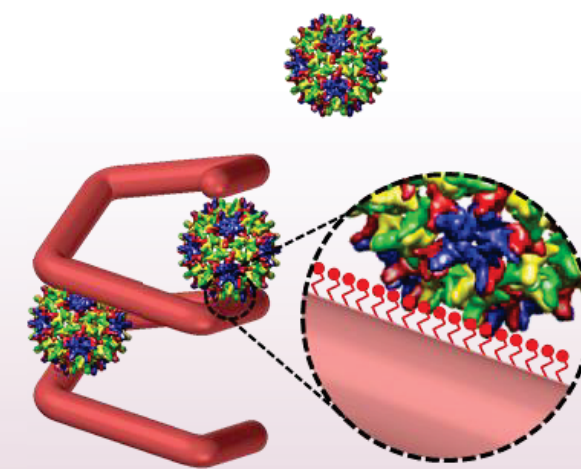

Viral attachment on bio-functionalized (self-assembled monolayers) nanoscaffold surfaces

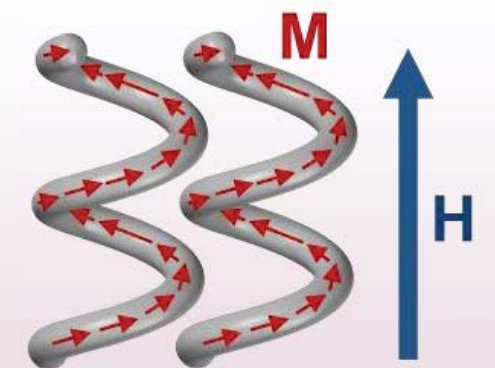

Chiral magnetic domain alignment in ferromagnetic core-shell helices. Preserve physical properties over time.

## Experimental Techniques

### Glancing Angle Deposition

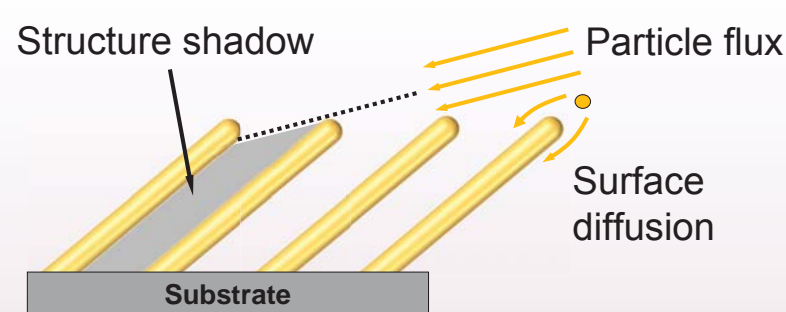

A collimated particle flux, generated by electron beam evaporation impinges at a glancing angle onto the substrate and results in self-organized, randomly distributed but highly coherent slanted nanocolumns (F1-STFs).

100 nm Co can still be transparent!

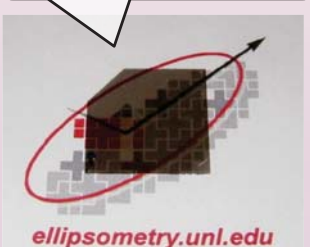

### Atomic Layer Deposition

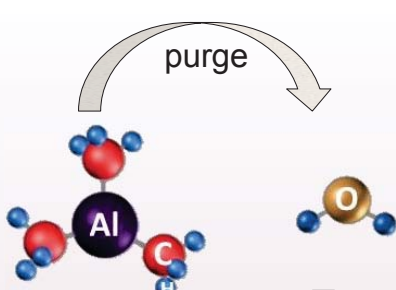

Subsequent cycling of Trimethylaluminum (TMA) and  $\text{H}_2\text{O}$

Three cycles result in a three monolayer thick conformal  $\text{Al}_2\text{O}_3$  coating

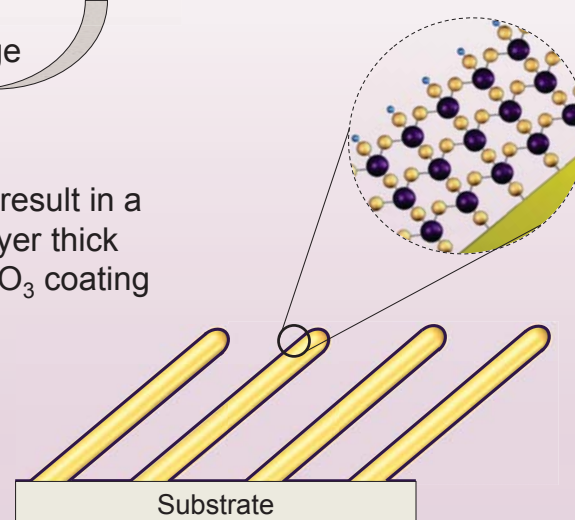

### Mueller Matrix Ellipsometry

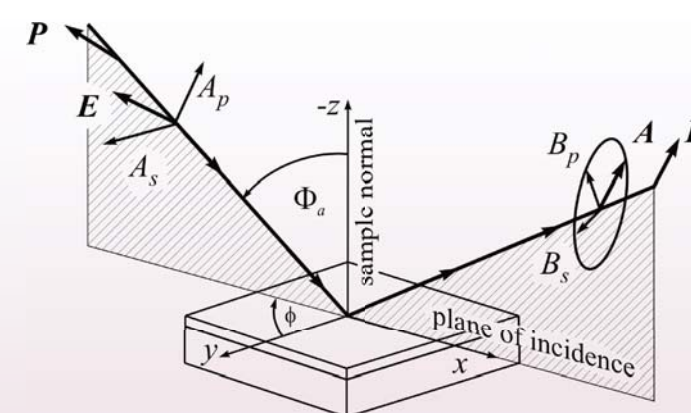

Ellipsometry measures the polarization state change of an electromagnetic wave upon reflection off a sample surface.

If the sample is anisotropic, spectroscopic Mueller matrix ellipsometry allows for determination of complete sets of optical constants.

The 4x4 real-valued Mueller matrix connects the incident and emergent Stokes vector components

$$\begin{bmatrix} S_0 \\ S_1 \\ S_2 \\ S_3 \end{bmatrix}_{\text{out}} = \begin{bmatrix} M_{11} & M_{12} & M_{13} & M_{14} \\ M_{21} & M_{22} & M_{23} & M_{24} \\ M_{31} & M_{32} & M_{33} & M_{34} \\ M_{41} & M_{42} & M_{43} & M_{44} \end{bmatrix} \begin{bmatrix} I_P + I_S \\ I_P - I_S \\ I_{45} - I_{-45} \\ I_{RC} - I_{LC} \end{bmatrix}_{\text{in}}$$

D. Schmidt *et al.* Appl. Phys. Lett. **94**, 011914 (2009).

## Results

### Optical Model

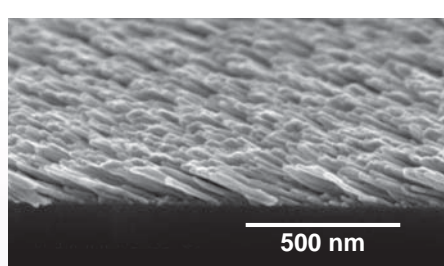

Scanning electron microscope image of a Co F1-STF (tilted 15°) and optical model equivalent



Spatially aligned, anisotropic inclusions with three major effective polarizabilities  $\mathbf{P}_{\text{eff},j}$  along principal axes  $j = a, b, c$  (based on Bruggeman)

$$\sum_{n=1}^m f \frac{\epsilon_n - \epsilon_{\text{eff},j}}{\epsilon_{\text{eff},j} + L_j(\epsilon_n - \epsilon_{\text{eff},j})} = 0$$

This model accounts for  $m$  different constituents with bulk-like optical constants  $\epsilon_n$ . Depolarization factors  $L_j$  represent the biaxial film geometry. A projection matrix is applied to transform the virtual orthogonal basis into a monoclinic system.

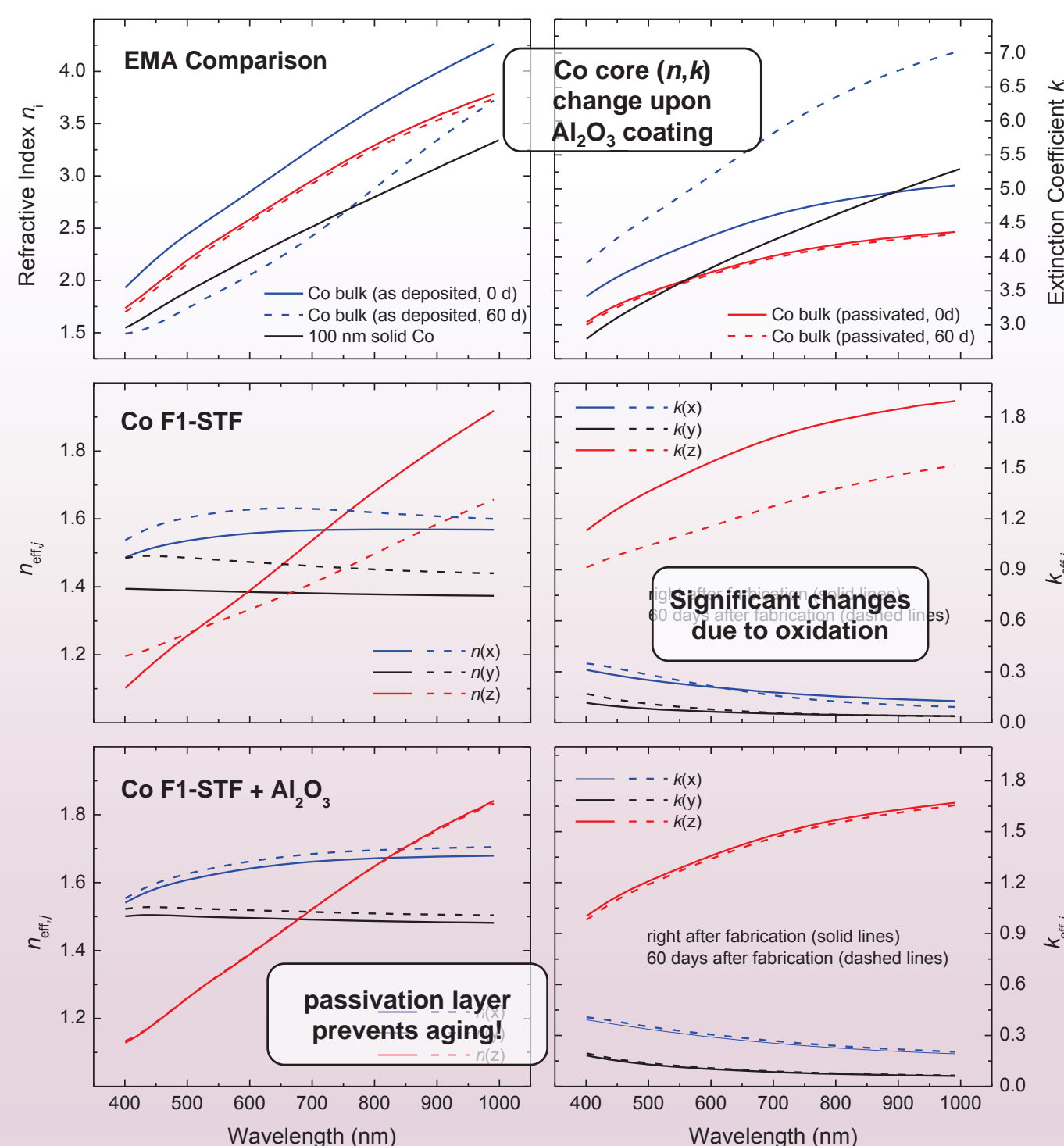

### Best-Match Model Parameters

Parameter	Co F1 (0 d)	Co F1 (after 60 d)	Co F1+Al <sub>2</sub> O <sub>3</sub> (0 d)	Co F1+Al <sub>2</sub> O <sub>3</sub> (after 60 d)
$t$ (nm)	84.80(3)	84.88(4)	89.46(3)	89.86(3)
$\theta$ (°)	62.52(1)	61.85(1)	62.69(1)	62.80(1)
$\beta$ (°)	80.91(3)	84.21(2)	82.96(2)	83.39(2)
$f_{\text{void}}$ (%)	75.99(1)	77.44(1)	62.03(1)	59.33(6)
$f_{\text{Al}_2\text{O}_3}$ (%)	---	---	13.98(8)*	16.74(6)*
$L_a^D$	0.3983(1)	0.3817(1)	0.4035(2)	0.4030(2)
$L_b^D$	0.5134(1)	0.4469(1)	0.5267(2)	0.5283(2)
$L_c^D$	0.0884(3)	0.1714(4)	0.0698(7)	0.0688(6)
MSE	12.45	13.42	8.45	10.82

\*marginal changes are attributed to humidity changes  
→ very sensitive optical humidity sensor

#### SEM Estimates

$r_{\text{avg}} = 11 \text{ nm}$  (Co F1)  
 $n_c \approx 360 \text{ columns}/\mu\text{m}^2$

#### Ellipsometry Results

$n_c = 302 \text{ columns}/\mu\text{m}^2$   
surface area  $\text{SA} = 4.9 \mu\text{m}^2$   
surface area to volume ratio  $\text{SA:V} = 190 \text{ m}^{-1}$

$\text{Al}_2\text{O}_3$  thickness  $t_{\text{AlO}} = 2.80 \text{ nm}$

$\text{Al}_2\text{O}_3$  ALD with identical parameters on 100 nm solid Co reference sample results in a layer thickness  $t_{\text{AlO}} = 3.29 \text{ nm}$